

ACCESSORI PER ANTINE SCORREVOLI

MiniSilent

ACCESSORIES FOR LITTLE SLIDING SHUTTERS

ACCESSOIRES POUR PETIT VANTAILS

GUIDA INFERIORE PER ANTINE, AD INCASSO, IN ALLUMINIO ANODIZZATO

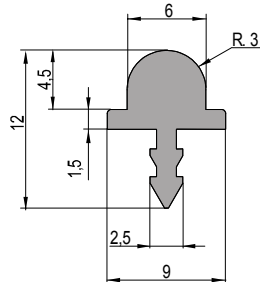
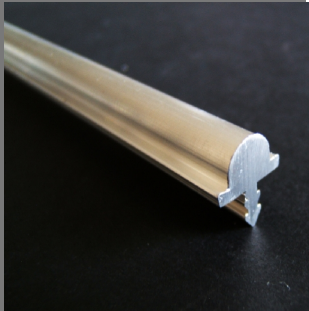

Lunghezza = 3 m
Length = 3 m
Longueur = 3 m

**NOVITÀ - NEW
NOUVEAU**

GIA/3A	Anodizzato argento Anodized aluminium Anodisé aluminium
GIA/3B	Anodizzato bronzo Anodized bronze Anodisé bronze
GIA/3N	Anodizzato nero Black anodized Anodisé noir

Lower guide for little shutters to be crated, in anodized aluminium.

Guide inférieure pour petit vantails à encastrer, en aluminium anodisé.

ART.	Confez. Box	Peso Kg Weight
GIA/3A	60 m n° 20x3 m	Kg/m 0,127
GIA/3B	60 m n° 20x3 m	Kg/m 0,127
GIA/3N	60 m n° 20x3 m	Kg/m 0,127

GUIDA SUPERIORE PER ANTINE, IN PLASTICA MARRONE, AD INCASSO

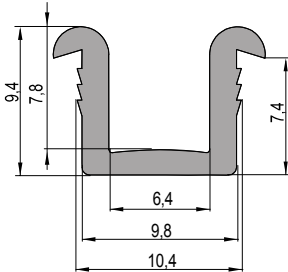
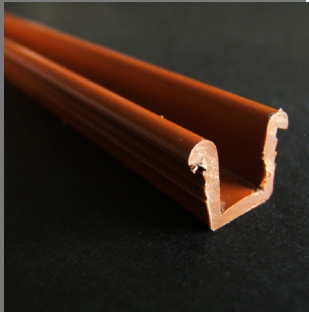

Lunghezza = 3 m
Length = 3 m
Longueur = 3 m

**NOVITÀ - NEW
NOUVEAU**

Upper guide for little shutters, in brown plastic, to be crated.

Guide supérieure pour petit vantails en plastique marron, à encastrer.

ART.	Confez. Box	Peso Kg Weight
GSA/3M	60 m n° 20x3 m	Kg/m 0,072

SET DI SCORREVOLI PER ANTINE



**NOVITÀ - NEW
NOUVEAU**

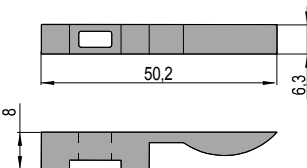

Set di accessori per antine scorrevoli.

Comprende:
n°2 carrelli ad incasso, in plastica nera e zama, ruota in nylon con cuscinetto a sfere
n°2 guide superiori in plastica nera, ad incasso, con perno a molla
n°2 stop, in plastica nera
n°1 sacchetto viterie

Set of accessories for sliding shutters, including:

n°2 trolleys to be crated in black plastic and zama, wheel in nylon with ball bearing
n°2 upper guides in black plastic, with spring pin
n°2 stops, in black plastic
Screws

Set d'accessoires pour vantails coulissants avec:
n°2 chariots à encastrer en plastique noir et zama, galet en nylon avec roulements à billes
n°2 guides supérieures en plastique noir à encastrer avec pivot à ressort
n°2 buté d'arrêt en plastique noir
n°1 sachet avec visserie

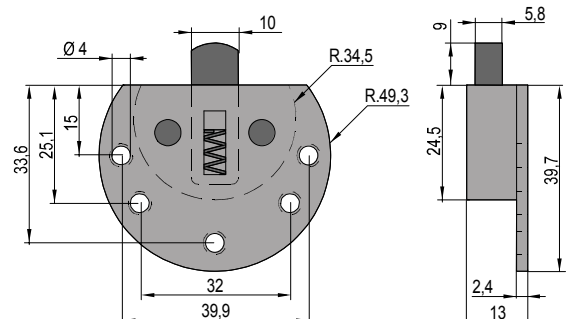
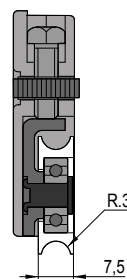
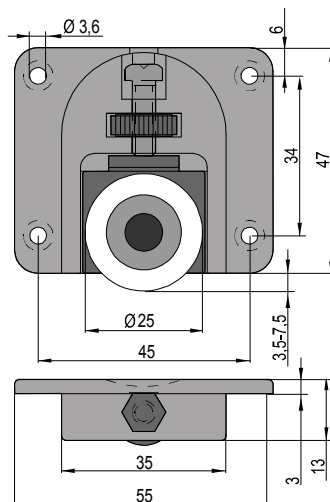

ART.	Portata Capacity	Confez. Box	Peso Kg Weight
S 50M	50 Kg/anta	24	0,120

Applicazione degli accessori per antine scorrevoli
 Application of the accessories for sliding shutters.
 Application des accessoires pour petit vantails.

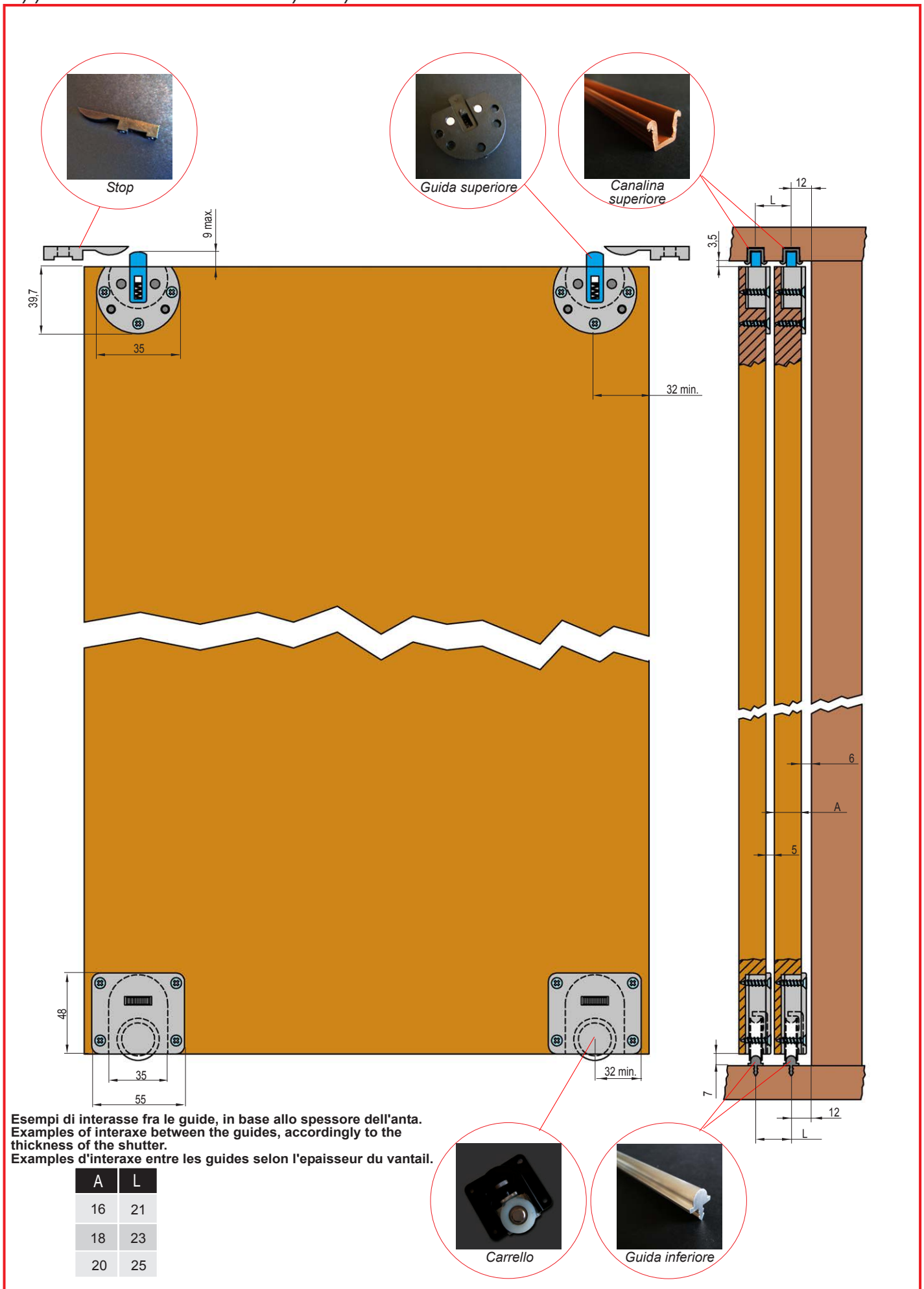



PETTITI GIUSEPPE s.p.a.

SERIE ASCO

COMPONENTI SCORREVOLI PER ANTINE - PANNELLI

SLIDING COMPONENTS FOR LITTLE WINGS - PANELS

COMPONENTS COULISSANTS POUR DEMI-PANNEAU

PATTINO A 1 RUOTA DIAMETRO 18

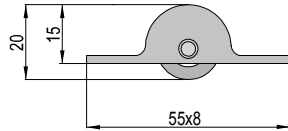

A/1	Ruota in acciaio zincato Wheels in zinked steel Roues en acier zingue	A/2	Ruota a gola in acciaio zincato Wheels grove in zinked steel Roues gorge en acier zingue
A/5	Ruota in delrin Wheels in delrin Roues en delrin	A/6	Ruota a gola in delrin Wheels grove in delrin Roues gorge en delrin

ART.	Confez. Box	Peso Kg Weight
A/1	100	0,015
A/5	100	0,010
A/2	100	0,015
A/6	100	0,010

Sliding block with 1 wheel ϕ 18.

Patin à 1 roulement avec ϕ 18.

PATTINO A 1 RUOTA DIAMETRO 24

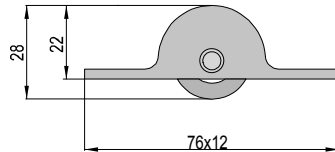

A/3	Ruota in acciaio zincato Wheels in zinked steel Roues en acier zingue	A/4	Ruota a gola in acciaio zincato Wheels grove in zinked steel Roues gorge en acier zingue
A/7	Ruota in delrin Wheels in delrin Roues en delrin	A/8	Ruota a gola in delrin Wheels grove in delrin Roues gorge en delrin

ART.	Confez. Box	Peso Kg Weight
A/3	100	0,045
A/7	100	0,035
A/4	100	0,040
A/8	100	0,030

Sliding block with 1 wheel ϕ 24.

Patin à 1 roulement avec ϕ 24.

GUIDA IN ACCIAIO PER PATTINI

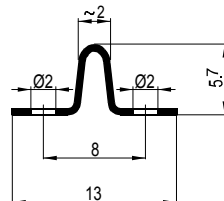
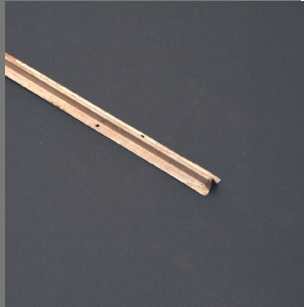

Lunghezza = 2 m
Length = 2 m
Longueur = 2 m

Guide in steel for sliding blocks (art.A/2-A/6 A/4-A/8).

Profil guide en acier pour patins (art.A/2A/6 A/4-A/8).

ART.	Confez. Box	Peso Kg Weight
AG/1	200 m n°100x2 m	Kg/m 0,065

GUIDA IN FIBRA PER PATTINI

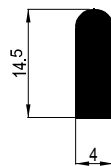

Lunghezza = 2 m
Length = 2 m
Longueur = 2 m

Guida in fibre for sliding blocks (art .A/4-4/8).

Guide en fibre pour patins (art.A/4-A/8).

ART.	Confez. Box	Peso Kg Weight
AG/3	200 m n°100x2 m	Kg/m 0,070

GUIDA IN ACCIAIO GREZZO

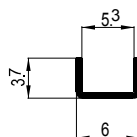
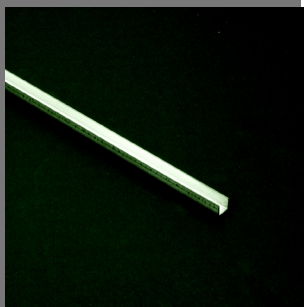

Lunghezza = 2 m
Length = 2 m
Longueur = 2 m

Guide in brass steel for sliding blocks (art.A/1-A/5).

Guide en acier laitonné pour patins (art.A/1-A/5).

ART.	Confez. Box	Peso Kg Weight
AG/4	200 m n°100x2 m	Kg/m 0,040



GUIDA IN ACCIAIO OTTONATO

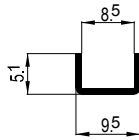

Lunghezza = 2 m
Length = 2 m
Longueur = 2 m

Guide in brass steel for sliding blocks.

Guide en acier laitoné pour patins .

ART.	Confez. Box	Peso Kg Weight	
AG/5	200 m n°100x2 m	Kg/m 0,070	

CATENACCIOLO RIENTRANTE IN ACCIAIO OTTONATO

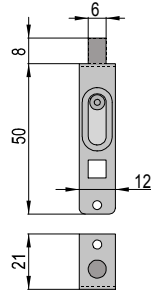

Reentering sliding bar in brass steel.

Verrou rentrant en acier laitoné.

AC/3	Rullo in nylon ϕ 6 Roller in nylon ϕ 6 Roulement in nylon ϕ 6		
------	--	--	--

CATENACCIOLO RIENTRANTE IN ACCIAIO OTTONATO

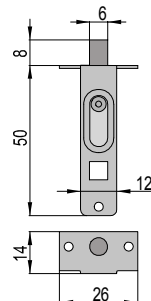
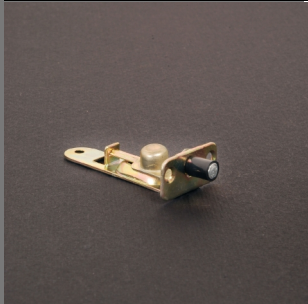

Reentering sliding bar in brass steel.

Verrou rentrant en acier laitoné.

AC/4	Rullo in nylon ϕ 6 Roller in nylon ϕ 6 Roulement in nylon ϕ 6		
------	--	--	--

GUIDA IN ACCIAIO OTTONATO PER CATENACCIOLO

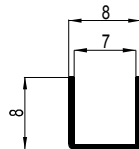

Lunghezza = 2 m
Length = 2 m
Longueur = 2 m

Guide in brass steel for sliding bars.

Guide en acier laitoné pour verroux.

ART.	Confez. Box	Peso Kg Weight	
AG/6	200 m n°100x2 m	Kg/m 0,080	

Tabella di accoppiamento pattini-guide - Table of corresponding sliding blocks-guides
Tableau de patins-guides correspondantes

ART.	AG/1	AG/3	AG/4	AG/5	AG/6
A/1			✓		
A/2	✓	✓			
A/3				✓	
A/4		✓			
A/5			✓		
A/6	✓	✓			
A/7				✓	
A/8		✓			
AC/3					✓
AC/4					✓



PETTITI GIUSEPPE s.p.a.

GUIDE PER CASSETTI

GUIDE AUTORIENTRANTI PER CASSETTI

SELF REENTERING SLIDES FOR DRAWERS

GLISSIÈRES AUTO-RENTRANTES POUR TIROIRS

GUIDE PER CASSETTI



Ogni set (2 Dx+2 Sx guide) = 1 cassetto
Every set (2 R+2 L slides) = 1 drawer
Chaque set (2 D+2 G glissières) = 1 tiroir

CONFEZIONATE IN SET

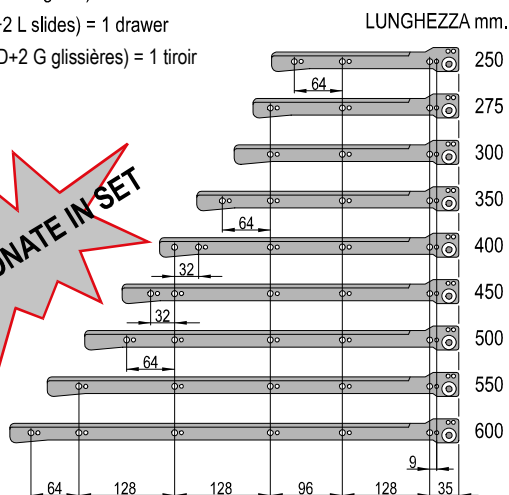

COLORE: Bianco (B), Marrone (M)
COLOUR: White (B), Brown (M)
COULEUR: Blanc (B), Marrón (M)

Guide autorientranti per cassetti, con "attacco al fondo", in acciaio, con ruote in delrin e verniciatura a polveri epossidiche.

Self reentering slides for drawers with "bottom pin", in steel, delrin rollers, powder epoxidated painting.

Glissières auto-rentrantes pour tiroirs, "attache en bas", en acier, avec roulettes en delrin et vernissage en poudre epoxy.

ART.	Confez. Box n. set	Peso Kg Weight	
GCA250	68	0,300	
GCA275	68	0,340	
GCA300	68	0,360	
GCA350	68	0,430	
GCA400	68	0,500	
GCA450	68	0,575	
GCA500	68	0,650	
GCA550	68	0,720	
GCA600	68	0,770	